

General Catalogue | Collection 2012



AUTOCARAVANS  
**RIMOR**







AUTOCARAVANS  
**RIMOR**



[www.rimor.it](http://www.rimor.it)

*Chi sceglie Rimor sa di poter contare sulla vera essenza delle cose. Da oltre 30 anni, infatti, accompagna i vostri viaggi all'aria aperta alla scoperta del mondo, con mezzi adatti ad ogni esigenza e con ampie possibilità di carico. Il nostro marchio è da sempre sinonimo di qualità unito alla massima funzionalità per garantirvi il comfort necessario a rigenerarvi in compagnia dei vostri cari. Il nostro approccio al mondo dell'autocaravan va oltre la produzione di veicoli ricreazionali, vogliamo creare ricordi che vi accompagnino oltre il tempo delle vostre vacanze. La gamma Rimor offre da sempre un'ampia varietà di piante e forniture per ogni tipologia di vacanza.*

*Everyone who chooses Rimor, chooses the true essence of things. For more than 30 years Rimor has been travelling with you on your outdoor trips to explore the world, with vehicles ideal for every need and with huge storage possibilities. Our brand has always been a symbol for quality and functionality in order to give you all the comfort you need to relax with your family and friends. Our approach to motor homes goes far beyond the mere production of vehicles. We want to create memories that last much longer than your holidays do. The Rimor brand has always been offering a huge variety of layouts and fittings for any type of holidays.*

*Wer Rimor wählt, entscheidet sich für die Essenz der Dinge. Seit 30 Jahren begleitet Rimor Sie in allen Ihren Reisen auf der Entdeckung der Welt, mit Wohnmobilen für jedes Bedürfnis und mit viel Platz für Ihre Sachen. Unsere Firma ist seit eh und je Symbol von Qualität und Funktionalität, um Ihnen den Komfort zu garantieren, um sich mit Ihrer Familie zu erholen. Unser Angebot geht weit über das Herstellen von Wohnmobilen hinaus, wir kreieren für Sie Erinnerungen, die Sie nach Ihrem Urlaub für immer begleiten werden. Die Rimor-Serie bietet Ihnen eine vielfältige Auswahl an, mit Layouts und Ausstattungen für jeden Geschmack und ideal für jede Art von Reisen.*

*Ceux qui font confiance à Rimor sauvent qu'ils peuvent compter sur la vraie essence des choses. Depuis trente ans Rimor accompagne vos voyages en plein air à la recherche du monde, avec des camping-cars pensés pour chacune de vos envies avec de larges espaces de chargement. Notre marque est une garantie de qualité et fonctionnalité pour vous assurer le confort nécessaire à vous régénérer avec ceux qui vous sont chers. Notre approche vers le monde du camping-car va au-delà de la production des véhicules, nous voulons créer des souvenirs qui vous suivront pendant vos vacances. La gamme Rimor offre depuis toujours une grande variété d'aménagements et d'équipements pour toutes les typologies de vacances.*

*Quien elige RIMOR sabe que puede contar con la verdadera esencia de las cosas. Desde hace 30 años RIMOR acompaña en sus viajes al aire libre descubriendo el mundo con medios adecuados a cada necesidad y con amplias posibilidades de carga. Nuestra marca es siempre sinónimo de calidad unido a la máxima funcionalidad para asegurarles el confort necesario en compañía de los suyos. Nuestro enfoque al mundo de la autocaravana va mas allá de la producción de dichos vehículos; RIMOR quiere conseguir recuerdos inolvidables que les acompañen en sus vacaciones. La gama RIMOR ofrece siempre una amplia variedad de diseños y la posibilidad adicional de personalizarlos solicitando el equipamiento a tal efecto.*

AUTOCARAVANS  
**RIMOR**

# Nemho

pag. 6



Nemho 59



Nemho 58



Nemho 55



# Sailer

pag. 16

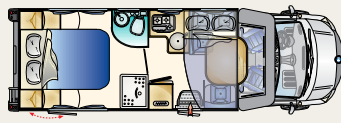

Sailer 95 Plus

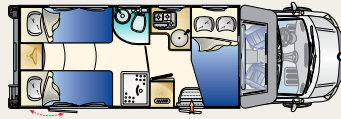

Sailer 95

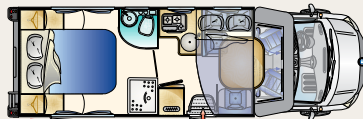

Sailer 69 Plus

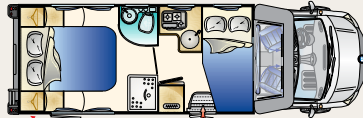

Sailer 69



Sailer 58 Plus



Sailer 58



# Europeo

pag. 26

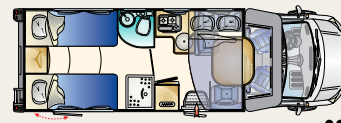

Europeo 95Plus

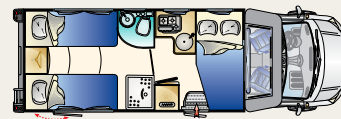

Europeo 95



Europeo 91Plus



Europeo 91



Europeo 89

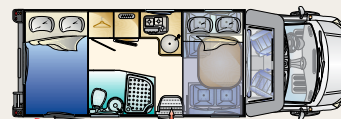

Europeo 87Plus



Europeo 87



# Europeo

pag. 26

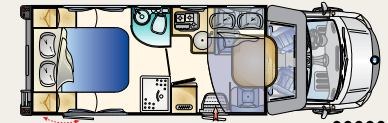

Europeo 69Plus



Europeo 69



Europeo 8

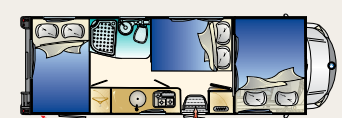

Europeo 5



Europeo 3



# Koala

pag. 40

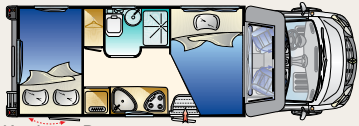

Koala 51P



Koala 50

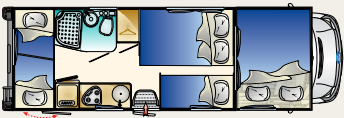

Koala 49



Koala 48



Koala 45



# Trimarano

pag. 52

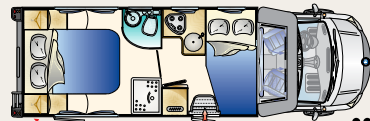

Trimarano 69P



Trimarano 9

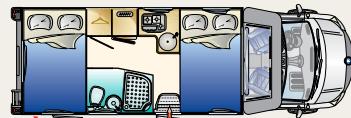

Trimarano 8P



Trimarano 8

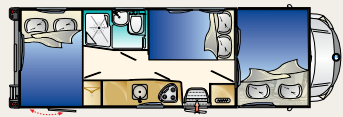

Trimarano 5



Trimarano 4



# Katamarano

pag. 60



Katamarano 12 P



Katamarano 7

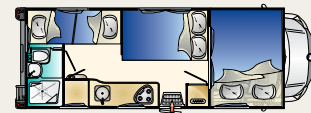

Katamarano 1

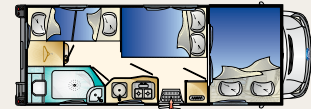

Katamarano 1 Light



Katamarano SOUND



# Horus

pag. 72

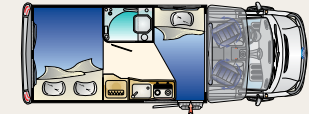

Horus



AUTOCARAVANS  
**RIMOR**





Tre mansardati di fascia alta che rappresentano il top della nostra offerta grazie ad allestimenti completi e soluzioni progettuali tra le più ricercate. Arredamento raffinato dal design moderno ed elegante, il Nemho utilizza un'illuminazione a LED ed una centralina touch screen di serie che rappresenta la novità tecnologica di questa stagione.

Three luxurious overcab models ranking in the forefront, owing to their complete outfit and technical solutions among the most sophisticated. Nemho with its modern and elegant first-rate furniture is equipped with LED lights and a serially included touch-screen control panel which is the technological innovation introduced this season on our vehicles.

Drei qualitativ hervorragende Alkovenmodelle, die dank der vollständigen Serienausstattung und Details nach dem neusten Stand der Technik das Top-Angebot von Rimor vervielfältigen. Das raffinierte Design ist zugleich modern und elegant. Die LED-Innenbeleuchtung und das Touch Screen-Kontrollfeld als Serienausstattung sind die grosse Neuheiten dieser Saison.

Trois mansardés représentent notre haut de gamme grâce aux équipements complets et solutions d'idées parmi le plus recherchées. L'aménagement y est raffiné et le design moderne et élégant. Le Nemho utilise un éclairage à led et un panneau de contrôle avec écran tactile de série qui est la nouveauté technologique de cette saison.

Tres capitonés en gama alta se presentan como el top de nuestra oferta gracias a la adaptación y las soluciones mas buscadas. Mobiliario refinado por el diseño moderno y elegante utilizando la iluminación de Led y centralita táctil de serie que representa las nuevas tecnologías tan presentes en esta temporada.



# Nemho

RIMOR



Nemho 58







# Nemho

RIMOR



Nemho 58

Nemho 58



Nemho 58



Nemho 58

Nemho 58







# Nemho

RIMOR



Nemho 58



Nemho 58

Nemho 58



Nemho 58





Nemho 58





# Nemho

RIMOR



**CENTRALINA** Novità tecnologica della stagione, la centralina ad interfaccia grafica permette di monitorare tutti gli apparati di bordo e di controllare ogni funzione del veicolo.

**CONTROL PANEL** The technically new developed, control panel with graphic interface makes it possible to monitor all the equipment on board and control every function of the vehicle.

**KONTROLL FELD** Die grosse technische Neuheit der Saison, mit graphischer Schnittstelle, das Ihnen ermöglicht, alle Bordgeräte und deren Funktionen optimal zu kontrollieren.

**PANNEAU DE CONTROLE** Nouveauté technologique de la saison, le panneau de contrôle avec interface graphique permet de commander tous les appareils de bord ainsi que toutes les fonctions de la cellule.

**CENTRALITA** Novedad tecnológica de la temporada, la centralita permite controlar todas las funciones a bordo mediante un gráfico en la pantalla.

## Nemho 59

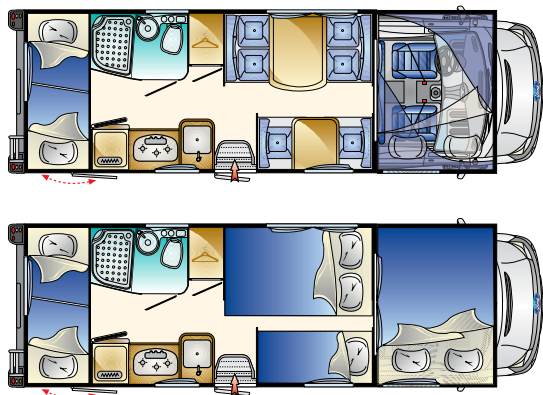

## Nemho 58

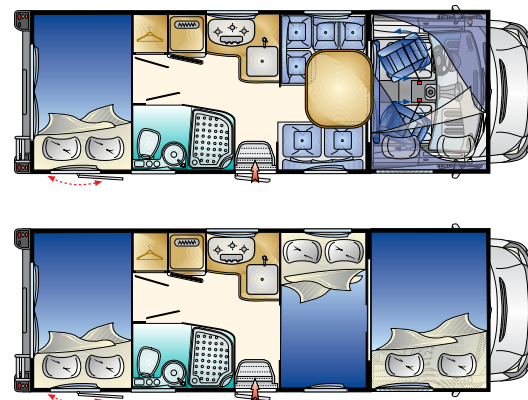

1310X710  
mm. 40+60  
lt. 100  
lt. 6+1  
5



1290X850  
mm. 40+60  
lt. 100  
lt. 6  
5

MISURE E PESI • DIMENSIONS AND WEIGHTS • MASSE UND GEWICHTE • DIMENSION ET POIDS • MEDIDAS Y PESOS

Lunghezza esterna • Outside length • Gesamtlänge •  
Longueur extérieure • Longitud externa (mm) 7365

Larghezza esterna - larghezza interna • Outside width  
- inside width • Gesamtbreite - Innenbreite • Largeur  
extérieure - intérieure • Anchura externa - Anchura interna  
(mm) 2340-2200

Altezza esterna fuori tutto - altezza interna • Maximum  
outside height - inside height • Gesamthöhe - Innenhöhe •  
Hauteur extérieure hors tout - intérieure • Altura externa -  
Altura interna (mm) 3000-1995

MISURE E PESI • DIMENSIONS AND WEIGHTS • MASSE UND GEWICHTE • DIMENSION ET POIDS • MEDIDAS Y PESOS

Lunghezza esterna • Outside length • Gesamtlänge •  
Longueur extérieure • Longitud externa (mm) 7265

Larghezza esterna - larghezza interna • Outside width  
- inside width • Gesamtbreite - Innenbreite • Largeur  
extérieure - intérieure • Anchura externa - Anchura interna  
(mm) 2340-2200

Altezza esterna fuori tutto - altezza interna • Maximum  
outside height - inside height • Gesamthöhe - Innenhöhe •  
Hauteur extérieure hors tout - intérieure • Altura externa -  
Altura interna (mm) 3000-1995



## Nemho 55

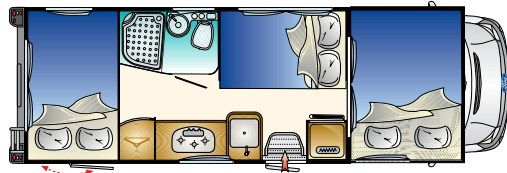
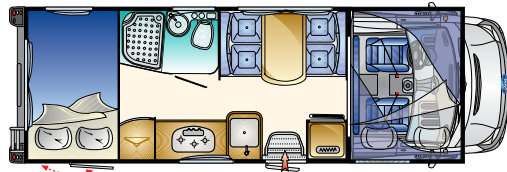

1290X850  
mm.

40+60  
lt.

100  
lt.

6

5

MISURE E PESI • DIMENSIONS AND WEIGHTS • MASSE UND GEWICHTE • DIMENSION ET POIDS • MEDIDAS Y PESOS

Lunghezza esterna • Outside length • Gesamtlänge •  
Longueur extérieure • Longitud externa (mm) 7265

Larghezza esterna - larghezza interna • Outside width  
- inside width • Gesamtbreite - Innenbreite • Largeur  
extérieure - intérieure • Anchura externa - Anchura interna  
(mm) 2340-2200

Altezza esterna fuori tutto - altezza interna • Maximum  
outside height - inside height • Gesamthöhe - Innenhöhe •  
Hauteur extérieure hors tout - intérieure • Altura externa -  
Altura interna (mm) 3000-1995

# Nemho

RIMOR

**GAVONE** Il gavone garantisce ottime possibilità di carico. Grazie alle due aperture laterali e alla torcia a LED è comodo e permette di caricare con facilità anche di notte. In alcuni modelli le dimensioni particolarmente ampie permettono di stivare anche oggetti ingombranti come un bici o uno scooter.

**LOCKER** The locker offers huge storage possibility. Owing to its two side-doors and a LED-light it can be easily loaded also at night. On some vehicles the large locker can effortlessly store also very cumbersome items, such as a bike or a scooter.

**STAUFACH** Das Staufach ist besonders gross und hat viel Platz. Dank zwei seitlichen Öffnungen und der LED-Beleuchtung ist es sehr bequem zu beladen auch bei Dunkelheit. In einigen Modellen haben Sie sogar Platz für grössere Gegenstände wie ein Fahrrad oder Scooter.

**SOUTE** La soute offre d'excellentes possibilités de chargement. Grâce aux deux ouvertures latérales et la présence de spots à led facilite son utilisation à la nuit tombée. Dans certains modèles les dimensions de la soute sont particulièrement grand ce qui permet de ranger un volume important de bagages, et même de recevoir des vélos ou un scooter.

**GARAJE** El garaje garantiza excelentes posibilidades de carga gracias a las dos aperturas laterales y a la buena ubicación de los Leds que permiten cargar cómoda y fácilmente también durante la noche. En algunos modelos las dimensiones particularmente amplias permiten fijar objetos voluminosos como bicis o motos actuando como un verdadero garaje convencional.





Prestante e con ottime possibilità di carico, il Sailer si contraddistingue per una linea aerodinamica e una organizzazione degli spazi interni secondo i più accurati criteri di ergonomia. Esuberante nelle prestazioni, il Sailer è un veicolo contenuto negli spazi esterni, affidabile e sicuro. La disposizione interna varia a seconda dei modelli; in ogni pianta è possibile avere un allestimento sempre completo, a garanzia di stile e comfort.

Good-looking and with outstanding loading possibilities, the Sailer is distinguished by its streamlined styling and interior spaces organised according to the most accurate ergonomic criteria. With its exuberant performance the Sailer is a vehicle with low overall exterior dimensions that is reliable and safe. The interior layout varies according to the models; every layout offers complete outfitting to warrant style and comfort.

Der stattliche Sailer mit seinen hervorragenden Lademöglichkeiten zeichnet sich durch eine aerodynamische Linie und eine gut organisierte Raumaufteilung unter strengster Beachtung ergonomischer Gesichtspunkte aus. Mit seinen außerordentlichen Leistungen, ist der Sailer ein zuverlässiges und sicheres Fahrzeug von geringen äußeren Abmessungen. Die Raumgestaltung ist je nach Modell unterschiedlich; mit jedem Grundriss ist eine immer komplette Ausstattung erhältlich, eine Garantie für Stil und Komfort.

D'une belle prestance et avec d'excellentes possibilités de chargement, le Sailer se distingue par une ligne aérodynamique et une organisation des espaces internes selon les critères les plus rigoureux de l'ergonomie. Avec ses performances exubérantes, le Sailer est un véhicule contenu dans ses espaces extérieurs, fiable et sûr. La disposition interne varie en fonction des modèles. Chaque plan d'aménagement met à disposition un équipement complet, en garantie du style et du confort.

De buen porte y con óptimas posibilidades de carga, Sailer se distingue por una línea aerodinámica y una organización de los espacios interiores según los más atentos criterios de ergonomía. Exhuberante en las prestaciones, Sailer es un vehículo moderado en los espacios exteriores, confiable y seguro. La disposición interior es diferente según los modelos; en cada planta es posible tener un equipamiento siempre completo, como garantía de estilo y comodidad.

AUTOCARAVANS  
**RIMOR**





# Sailer

RIMOR



Sailer 95





# Sailer

RIMOR



Sailer 95



Sailer 95



Sailer 95



Sailer 95









Sailer 95

Sailer 95



Sailer 95





Sailer 95







# Sailer

RIMOR



**CENTRALINA** Novità tecnologica della stagione, la centralina ad interfaccia grafica permette di monitorare tutti gli apparati di bordo e di controllare ogni funzione del veicolo.

**CONTROL PANEL** The technically new developed, control panel with graphic interface makes it possible to monitor all the equipment on board and control every function of the vehicle.

**KONTROLL FELD** Die grosse technische Neuheit der Saison, mit graphischer Schnittstelle, das Ihnen ermöglicht, alle Bordgeräte und deren Funktionen optimal zu kontrollieren.

**PANNEAU DE CONTROLE** Nouveauté technologique de la saison, le panneau de contrôle avec interface graphique permet de commander tous les appareils de bord ainsi que toutes les fonctions de la cellule.

**CENTRALITA** Novedad tecnológica de la temporada, la centralita permite controlar todas las funciones a bordo mediante un gráfico en la pantalla.

## Sailer 95Plus

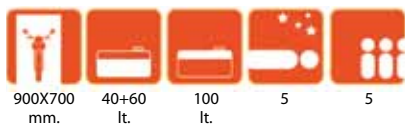
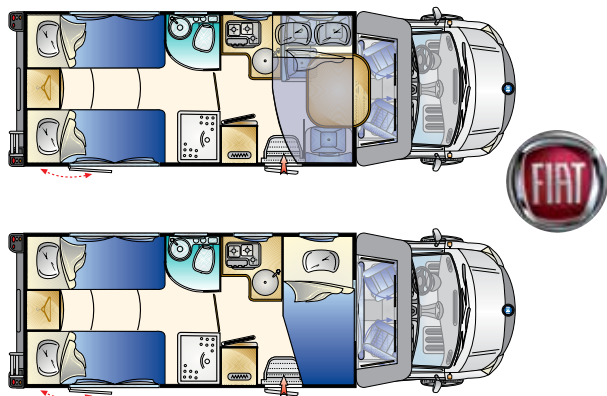

MISURE E PESI • DIMENSIONS AND WEIGHTS • MASSE UND GEWICHTE • DIMENSION ET POIDS • MEDIDAS Y PESOS

Lunghezza esterna • Outside length • Gesamtlänge • Longueur extérieure • Longitud externa (mm) 7414

Larghezza esterna - larghezza interna • Outside width - inside width • Gesamtbreite - Innenbreite • Largeur extérieure - intérieure • Anchura externa - Anchura interna (mm) 2340-2200

Altezza esterna fuori tutto - altezza interna • Maximum outside height - inside height • Gesamthöhe - Innenhöhe • Hauteur extérieure hors tout - intérieure • Altura externa - Altura interna (mm) 2900-1995

## Sailer 95

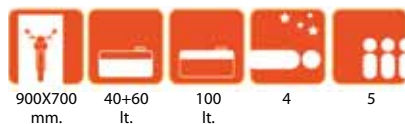
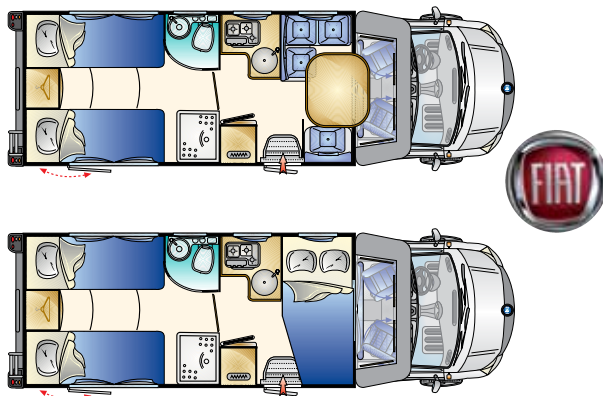

MISURE E PESI • DIMENSIONS AND WEIGHTS • MASSE UND GEWICHTE • DIMENSION ET POIDS • MEDIDAS Y PESOS

Lunghezza esterna • Outside length • Gesamtlänge • Longueur extérieure • Longitud externa (mm) 7414

Larghezza esterna - larghezza interna • Outside width - inside width • Gesamtbreite - Innenbreite • Largeur extérieure - intérieure • Anchura externa - Anchura interna (mm) 2340-2200

Altezza esterna fuori tutto - altezza interna • Maximum outside height - inside height • Gesamthöhe - Innenhöhe • Hauteur extérieure hors tout - intérieure • Altura externa - Altura interna (mm) 2900-1995

## Sailer 69 Plus

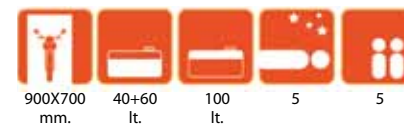
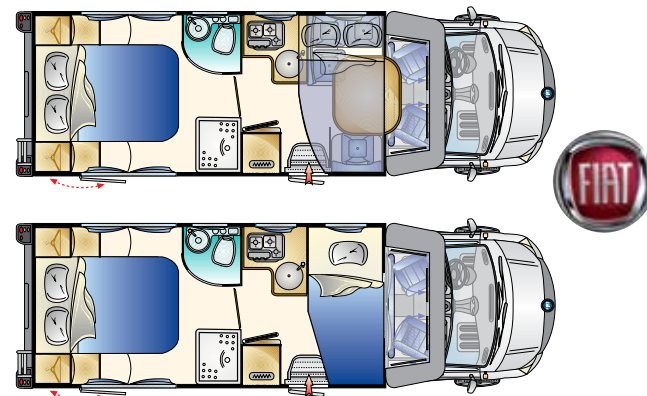

MISURE E PESI • DIMENSIONS AND WEIGHTS • MASSE UND GEWICHTE • DIMENSION ET POIDS • MEDIDAS Y PESOS

Lunghezza esterna • Outside length • Gesamtlänge • Longueur extérieure • Longitud externa (mm) 7415

Larghezza esterna - larghezza interna • Outside width - inside width • Gesamtbreite - Innenbreite • Largeur extérieure - intérieure • Anchura externa - Anchura interna (mm) 2340-2200

Altezza esterna fuori tutto - altezza interna • Maximum outside height - inside height • Gesamthöhe - Innenhöhe • Hauteur extérieure hors tout - intérieure • Altura externa - Altura interna (mm) 2900-1995



## Sailer 69

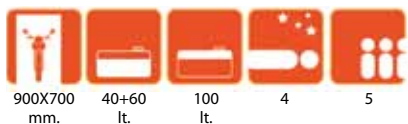
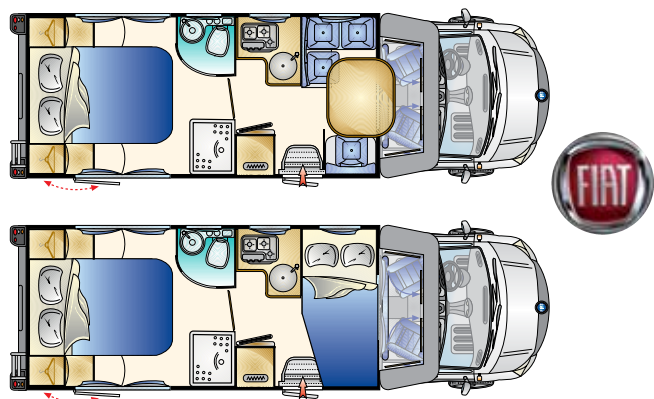

MISURE E PESI • DIMENSIONS AND WEIGHTS • MASSE UND GEWICHTE • DIMENSION ET POIDS • MEDIDAS Y PESOS

Lunghezza esterna • Outside length • Gesamtlänge • Longueur extérieure • Longitud externa (mm) 7415

Larghezza esterna - larghezza interna • Outside width - inside width • Gesamtbreite - Innenbreite • Largeur extérieure - intérieure • Anchura externa - Anchura interna (mm) 2340-2200

Altezza esterna fuori tutto - altezza interna • Maximum outside height - inside height • Gesamthöhe - Innenhöhe • Hauteur extérieure hors tout - intérieure • Altura externa - Altura interna (mm) 2900-1995

## Sailer 58 Plus

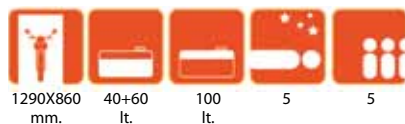
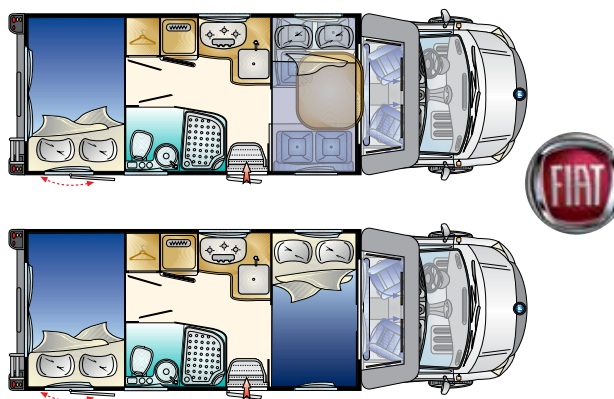

MISURE E PESI • DIMENSIONS AND WEIGHTS • MASSE UND GEWICHTE • DIMENSION ET POIDS • MEDIDAS Y PESOS

Lunghezza esterna • Outside length • Gesamtlänge • Longueur extérieure • Longitud externa (mm) 7415

Larghezza esterna - larghezza interna • Outside width - inside width • Gesamtbreite - Innenbreite • Largeur extérieure - intérieure • Anchura externa - Anchura interna (mm) 2340-2200

Altezza esterna fuori tutto - altezza interna • Maximum outside height - inside height • Gesamthöhe - Innenhöhe • Hauteur extérieure hors tout - intérieure • Altura externa - Altura interna (mm) 2900-1995

## Sailer 58

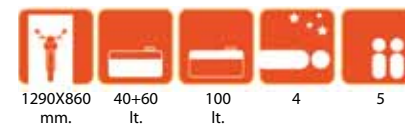
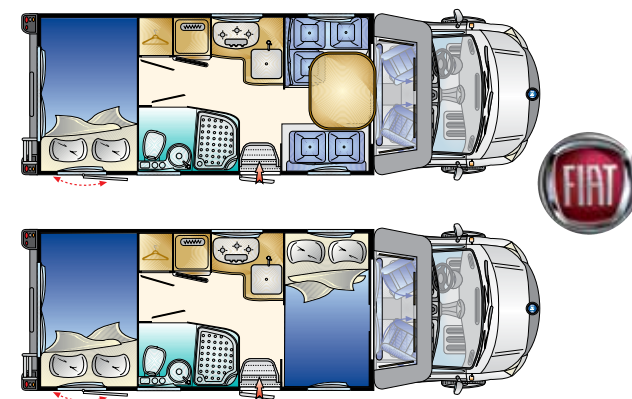

MISURE E PESI • DIMENSIONS AND WEIGHTS • MASSE UND GEWICHTE • DIMENSION ET POIDS • MEDIDAS Y PESOS

Lunghezza esterna • Outside length • Gesamtlänge • Longueur extérieure • Longitud externa (mm) 7415

Larghezza esterna - larghezza interna • Outside width - inside width • Gesamtbreite - Innenbreite • Largeur extérieure - intérieure • Anchura externa - Anchura interna (mm) 2340-2200

Altezza esterna fuori tutto - altezza interna • Maximum outside height - inside height • Gesamthöhe - Innenhöhe • Hauteur extérieure hors tout - intérieure • Altura externa - Altura interna (mm) 2900-1995



La serie Europeo offre mansardati e semintegrali che grazie all'intelligente disposizione interna (come la dinette trasformabile e la mansarda ad altezza massimamente utile) si dimostrano adatti a qualsiasi tipologia di equipaggio. I mezzi di questa linea si distinguono per la maneggevolezza garantita sia in fase di manovra che di marcia senza rinunciare alla comodità di usufruire di grandi spazi di carico.

The Europeo series offers overcab and low profile models, which, thanks to the intelligent interior layout (such as the convertible dinette and the overcab with the maximum useful height) prove to be suitable for any type of crew. The models of this line are distinguished by their ease of handling during both manoeuvres and on the move without forsaking the convenience of big loading spaces.

Die Europeo-Serie Alkoven- und halbintegrierte Modelle, die sich dank der intelligent gestalteten Inneneinrichtung (wie die verstellbare Dinette und der Alkoven mit einer maximalen Nutzhöhe) an jeden Mannschaftstyp anpassen. Die Fahrzeuge dieser Serie unterscheiden sich durch ihre Handlichkeitsgarantie sowohl beim Manövrieren als auch während der Fahrt, ohne dabei auf die Bequemlichkeit der Nutzung von großen Ladeflächen zu verzichten.

La série Europeo est composée de modèles à capucine et profilés, qui, grâce à une disposition interne judicieuse (comme la dinette transformable et la capucine à hauteur utile maximum) s'adaptent à tous les types d'équipage. Les véhicules de cette ligne se distinguent par leur maniabilité aussi bien pendant les manœuvres qu'en roulant, sans pour autant renoncer au confort de disposer de grands espaces de chargement.

La serie Europeo ofrece capuchinas y semi-integrales que, gracias a la inteligente disposición interna (como el comedor transformable y la capuchina con la máxima altura útil) se muestran aptas para cualquier tipologia de pasajeros. Los vehículos de esta línea se distinguen por la manejabilidad garantizada, tanto en fase de maniobra como de marcha, sin renunciar a la comodidad de hacer uso de grandes espacios de carga.



# Europeo

RIMOR



Europeo 5





Europeo 5



Europeo 5





Europeo 5



Europeo 5



Europeo 5









# Europeo

RIMOR



Europeo 69 Plus



Europeo 69 Plus









Europeo 69 Plus



Europeo 69 Plus



Europeo 69 Plus

## Europeo 95 Plus

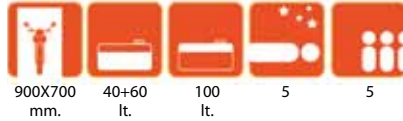
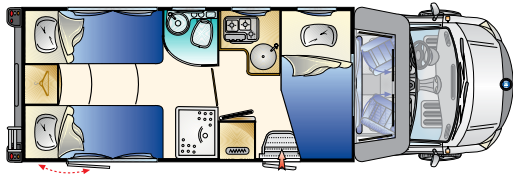
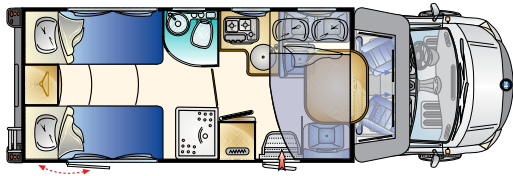

## Europeo 91 Plus

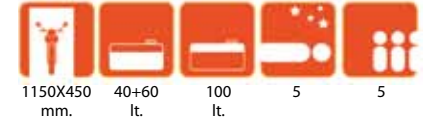
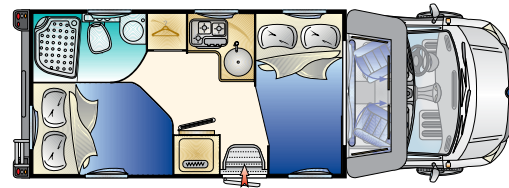
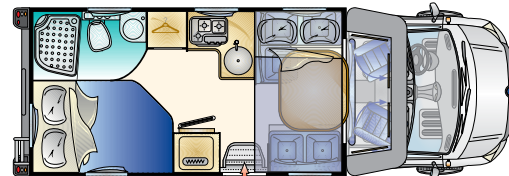

## Europeo 95

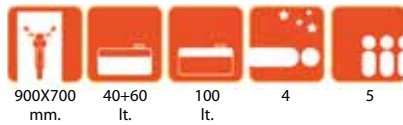
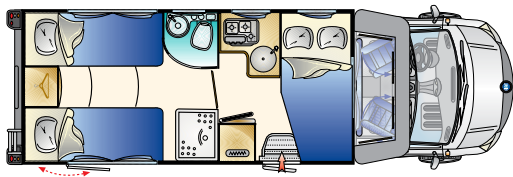
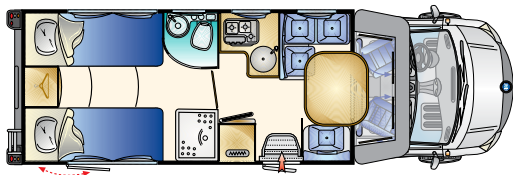

## Europeo 91

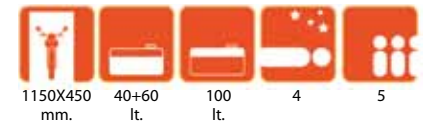
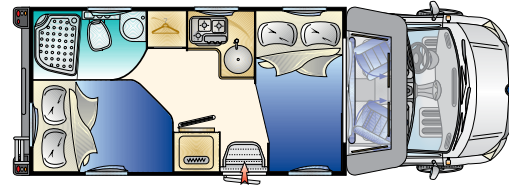
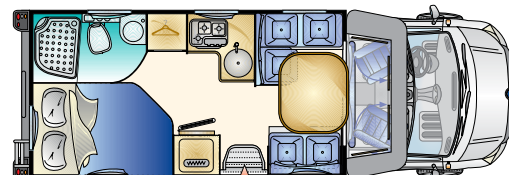

MISURE E PESI • DIMENSIONS AND WEIGHTS • MASSE UND GEWICHTE • DIMENSION ET POIDS • MEDIDAS Y PESOS

Lunghezza esterna • Outside length • Gesamtlänge • Longueur extérieure • Longitud externa (mm)

7414

Larghezza esterna - larghezza interna • Outside width - inside width • Gesamtbreite - Innenbreite • Largeur extérieure - intérieure • Anchura externa - Anchura interna (mm)

2340-2200

Altezza esterna fuori tutto - altezza interna • Maximum outside height - inside height • Gesamthöhe - Innenhöhe • Hauteur extérieure hors tout - intérieure • Altura externa - Altura interna (mm)

2900-1995

MISURE E PESI • DIMENSIONS AND WEIGHTS • MASSE UND GEWICHTE • DIMENSION ET POIDS • MEDIDAS Y PESOS

Lunghezza esterna • Outside length • Gesamtlänge • Longueur extérieure • Longitud externa (mm)

6718

Larghezza esterna - larghezza interna • Outside width - inside width • Gesamtbreite - Innenbreite • Largeur extérieure - intérieure • Anchura externa - Anchura interna (mm)

2340-2200

Altezza esterna fuori tutto - altezza interna • Maximum outside height - inside height • Gesamthöhe - Innenhöhe • Hauteur extérieure hors tout - intérieure • Altura externa - Altura interna (mm)

2900-1995



## Europeo 87 Plus

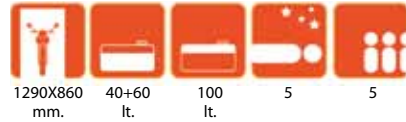
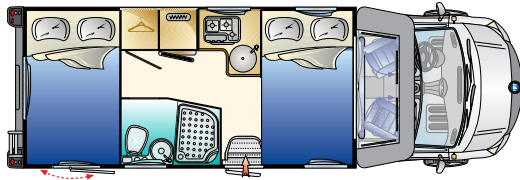
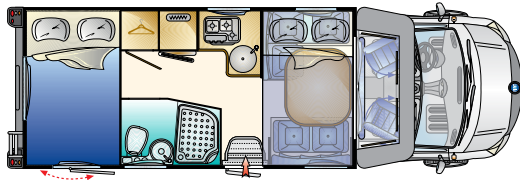

## Europeo 69 Plus

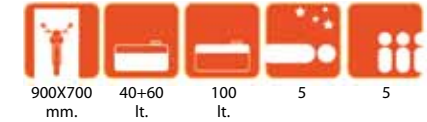
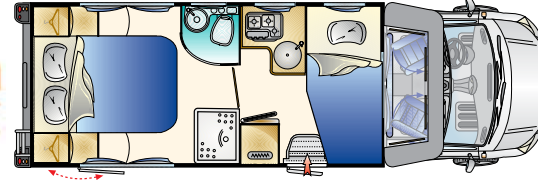
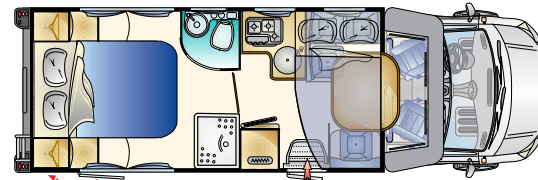

## Europeo 87

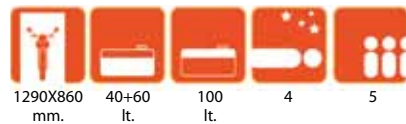
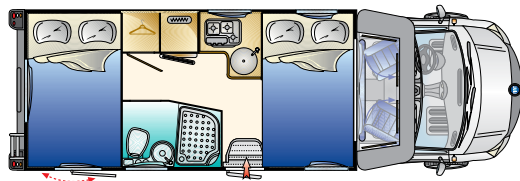
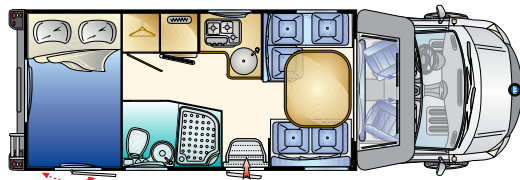

## Europeo 69

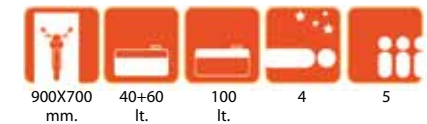
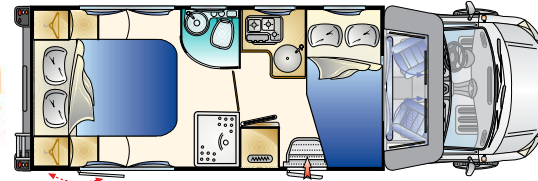
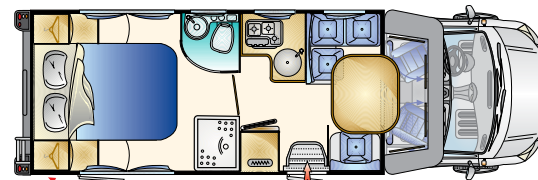

MISURE E PESI • DIMENSIONS AND WEIGHTS • MASSE UND GEWICHTE • DIMENSION ET POIDS • MEDIDAS Y PESOS

Lunghezza esterna • Outside length • Gesamtlänge •  
Longueur extérieure • Longitud externa (mm)

7153

Larghezza esterna - larghezza interna • Outside width  
- inside width • Gesamtbreite - Innenbreite • Largeur  
extérieure - intérieure • Anchura externa - Anchura interna  
(mm)

2340-2200

Altezza esterna fuori tutto - altezza interna • Maximum  
outside height - inside height • Gesamthöhe - Innenhöhe •  
Hauteur extérieure hors tout - intérieure • Altura externa -  
Altura interna (mm)

2900-1995

MISURE E PESI • DIMENSIONS AND WEIGHTS • MASSE UND GEWICHTE • DIMENSION ET POIDS • MEDIDAS Y PESOS

Lunghezza esterna • Outside length • Gesamtlänge •  
Longueur extérieure • Longitud externa (mm)

7414

Larghezza esterna - larghezza interna • Outside width  
- inside width • Gesamtbreite - Innenbreite • Largeur  
extérieure - intérieure • Anchura externa - Anchura interna  
(mm)

2340-2200

Altezza esterna fuori tutto - altezza interna • Maximum  
outside height - inside height • Gesamthöhe - Innenhöhe •  
Hauteur extérieure hors tout - intérieure • Altura externa -  
Altura interna (mm)

2900-1995

## Europeo 89

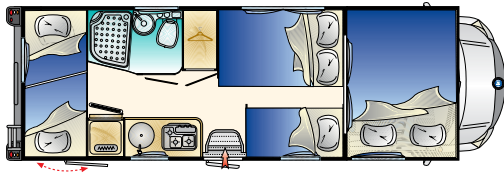
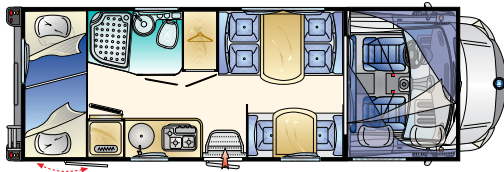

1310X710  
mm. 40+60  
lt. 100  
lt. 6+1  
5

## Europeo 8

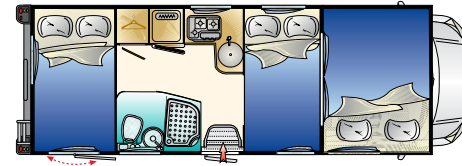
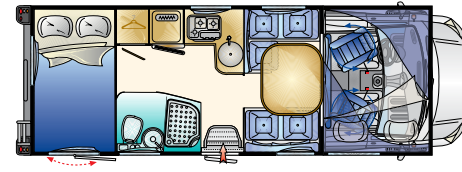

1290X860  
mm. 40+60  
lt. 100  
lt. 6  
5

### MISURE E PESI • DIMENSIONS AND WEIGHTS • MASSE UND GEWICHTE • DIMENSION ET POIDS • MEDIDAS Y PESOS

Lunghezza esterna • Outside length • Gesamtlänge •  
Longueur extérieure • Longitud externa (mm) 7369

Larghezza esterna - larghezza interna • Outside width  
- inside width • Gesamtbreite - Innenbreite • Largeur  
extérieure - intérieure • Anchura externa - Anchura interna  
(mm) 2240-2100

Altezza esterna fuori tutto - altezza interna • Maximum  
outside height - inside height • Gesamthöhe - Innenhöhe •  
Hauteur extérieure hors tout - intérieure • Altura externa -  
Altura interna (mm) 3000-1995

### MISURE E PESI • DIMENSIONS AND WEIGHTS • MASSE UND GEWICHTE • DIMENSION ET POIDS • MEDIDAS Y PESOS

Lunghezza esterna • Outside length • Gesamtlänge •  
Longueur extérieure • Longitud externa (mm) 7214

Larghezza esterna - larghezza interna • Outside width  
- inside width • Gesamtbreite - Innenbreite • Largeur  
extérieure - intérieure • Anchura externa - Anchura interna  
(mm) 2340-2200

Altezza esterna fuori tutto - altezza interna • Maximum  
outside height - inside height • Gesamthöhe - Innenhöhe •  
Hauteur extérieure hors tout - intérieure • Altura externa -  
Altura interna (mm) 3000-1995



## Europeo 5

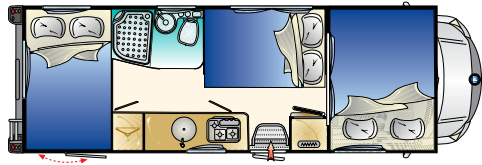
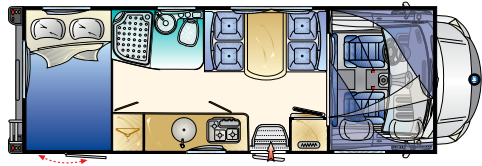

1290X860  
mm. 40+60  
lt. 100  
lt. 6 6

MISURE E PESI • DIMENSIONS AND WEIGHTS • MASSE UND GEWICHTE • DIMENSION ET POIDS • MEDIDAS Y PESOS

Lunghezza esterna • Outside length • Gesamtlänge •  
Longueur extérieure • Longitud externa (mm) 7153

Larghezza esterna - larghezza interna • Outside width  
- inside width • Gesamtbreite - Innenbreite • Largeur  
extérieure - intérieure • Anchura externa - Anchura interna  
(mm) 2340-2200

Altezza esterna fuori tutto - altezza interna • Maximum  
outside height - inside height • Gesamthöhe - Innenhöhe •  
Hauteur extérieure hors tout - intérieure • Altura externa -  
Altura interna (mm) 3000-1995

## Europeo 4

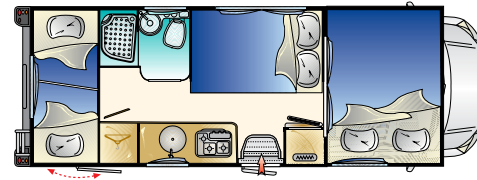
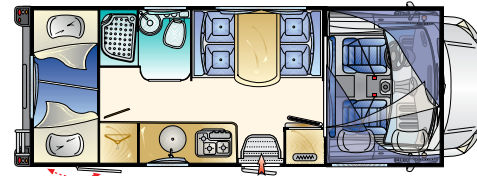

1310X710  
mm. 40+60  
lt. 100  
lt. 6 6

MISURE E PESI • DIMENSIONS AND WEIGHTS • MASSE UND GEWICHTE • DIMENSION ET POIDS • MEDIDAS Y PESOS

Lunghezza esterna • Outside length • Gesamtlänge •  
Longueur extérieure • Longitud externa (mm) 6683

Larghezza esterna - larghezza interna • Outside width  
- inside width • Gesamtbreite - Innenbreite • Largeur  
extérieure - intérieure • Anchura externa - Anchura interna  
(mm) 2340-2200

Altezza esterna fuori tutto - altezza interna • Maximum  
outside height - inside height • Gesamthöhe - Innenhöhe •  
Hauteur extérieure hors tout - intérieure • Altura externa -  
Altura interna (mm) 3000-1995



I cinque modelli: un semintegrale e quattro mansardati coniugano in modo ottimale la qualità con la semplicità e facilità nella gestione del mezzo. Nuove stoffe e nuovi colori accompagnano una pianta ben studiata rendendola fresca e giovane.

The five models (a low-profile and four overcab models) perfectly combine quality with simplicity. New fabrics and colours and a well-organized layout make a very fresh and youthful model of the Koala.

Die fünf Modelle, ein Teilintegrierter und vier Alkovenmodelle vereinigen optimal Qualität und Einfachheit dieser Serie. Neue Polsterstoffe und Farben für ein gut durchdachtes Design mit frischem und jugendlichen Touch.

Les cinq modèles : un semi-intégral et quatre mansardés associent avec brio, qualité et simplicité pour en faire des véhicules agréables à vivre et faciles à gérer. De nouveaux tissus et nouveaux coloris accompagnent un agencement bien conçu en obtenant un résultat vif et jeune.

En 5 modelos: un perfilado y cuatro capitonés que conjugan de modo óptimo la calidad con la comodidad y facilidad en la función del vehículo. Nuevas tapicerías y nuevos colores acompañan a cada distribución haciéndola cada vez mas joven y dinámica.

AUTOCARAVANS  
**RIMOR**





# Koala

RIMOR



Koala 48





# Koala

RIMOR



Koala 48



Koala 48





# Koala

RIMOR



Koala 48

Koala 48



Koala 48







# Koala

RIMOR



Koala 50



Koala 50









Koala 50



Koala 50



## Koala 51P

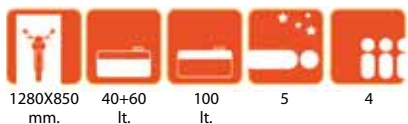
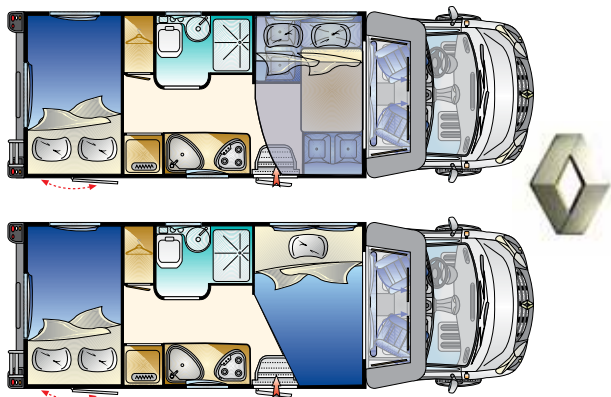

MISURE E PESI • DIMENSIONS AND WEIGHTS • MASSE UND GEWICHTE • DIMENSION ET POIDS • MEDIDAS Y PESOS

Lunghezza esterna • Outside length • Gesamtlänge • Longueur extérieure • Longitud externa (mm)    7277

Larghezza esterna - larghezza interna • Outside width - inside width • Gesamtbreite - Innenbreite • Largeur extérieure - intérieure • Anchura externa - Anchura interna (mm)    2340-2200

Altezza esterna fuori tutto - altezza interna • Maximum outside height - inside height • Gesamthöhe - Innenhöhe • Hauteur extérieure hors tout - intérieure • Altura externa - Altura interna (mm)    2850-1995

## Koala 50

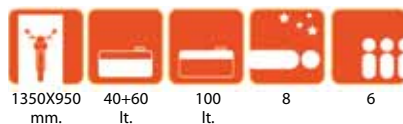
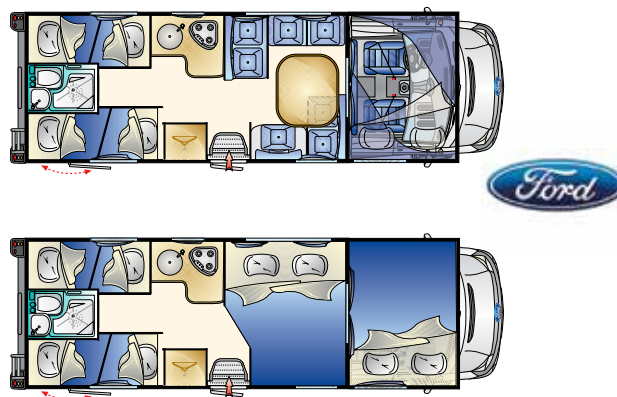

MISURE E PESI • DIMENSIONS AND WEIGHTS • MASSE UND GEWICHTE • DIMENSION ET POIDS • MEDIDAS Y PESOS

Lunghezza esterna • Outside length • Gesamtlänge • Longueur extérieure • Longitud externa (mm)    7365

Larghezza esterna - larghezza interna • Outside width - inside width • Gesamtbreite - Innenbreite • Largeur extérieure - intérieure • Anchura externa - Anchura interna (mm)    2340-2200

Altezza esterna fuori tutto - altezza interna • Maximum outside height - inside height • Gesamthöhe - Innenhöhe • Hauteur extérieure hors tout - intérieure • Altura externa - Altura interna (mm)    2900-1995

## Koala 49

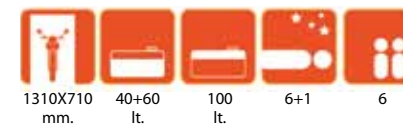
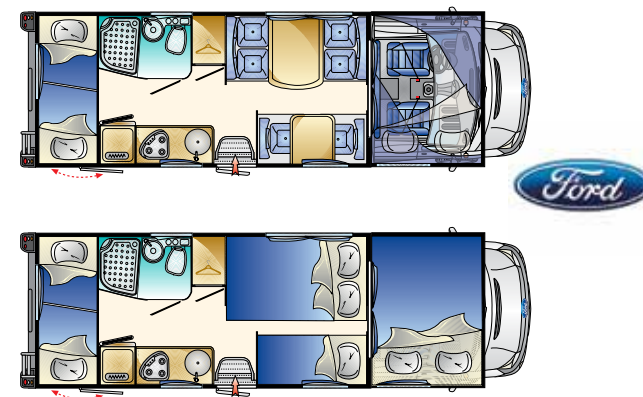

MISURE E PESI • DIMENSIONS AND WEIGHTS • MASSE UND GEWICHTE • DIMENSION ET POIDS • MEDIDAS Y PESOS

Lunghezza esterna • Outside length • Gesamtlänge • Longueur extérieure • Longitud externa (mm)    7365

Larghezza esterna - larghezza interna • Outside width - inside width • Gesamtbreite - Innenbreite • Largeur extérieure - intérieure • Anchura externa - Anchura interna (mm)    2240-2100

Altezza esterna fuori tutto - altezza interna • Maximum outside height - inside height • Gesamthöhe - Innenhöhe • Hauteur extérieure hors tout - intérieure • Altura externa - Altura interna (mm)    2900-1995



## Koala 48

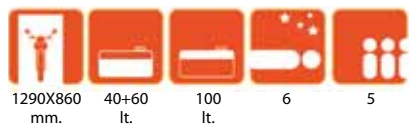
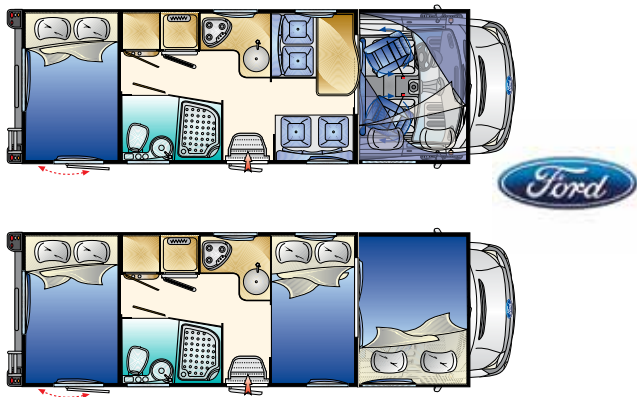

MISURE E PESI • DIMENSIONS AND WEIGHTS • MASSE UND GEWICHTE • DIMENSION ET POIDS • MEDIDAS Y PESOS

Lunghezza esterna • Outside length • Gesamtlänge • Longueur extérieure • Longitud externa (mm) 7255

Larghezza esterna - larghezza interna • Outside width - inside width • Gesamtbreite - Innenbreite • Largeur extérieure - intérieure • Anchura externa - Anchura interna (mm) 2240-2100

Altezza esterna fuori tutto - altezza interna • Maximum outside height - inside height • Gesamthöhe - Innenhöhe • Hauteur extérieure hors tout - intérieure • Altura externa - Altura interna (mm) 2900-1995

## Koala 45

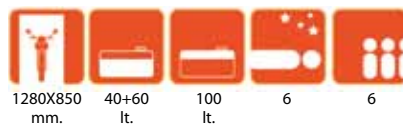
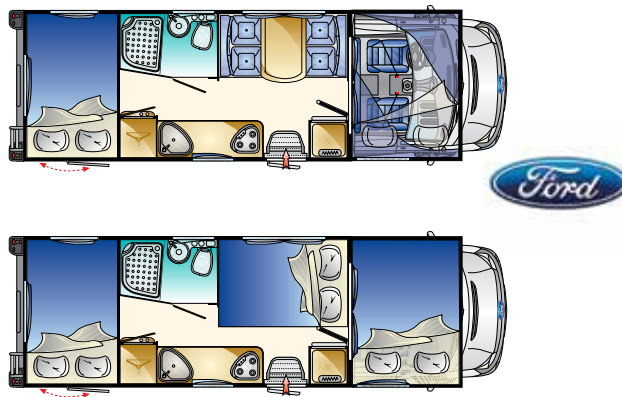

MISURE E PESI • DIMENSIONS AND WEIGHTS • MASSE UND GEWICHTE • DIMENSION ET POIDS • MEDIDAS Y PESOS

Lunghezza esterna • Outside length • Gesamtlänge • Longueur extérieure • Longitud externa (mm) 7255

Larghezza esterna - larghezza interna • Outside width - inside width • Gesamtbreite - Innenbreite • Largeur extérieure - intérieure • Anchura externa - Anchura interna (mm) 2240-2100

Altezza esterna fuori tutto - altezza interna • Maximum outside height - inside height • Gesamthöhe - Innenhöhe • Hauteur extérieure hors tout - intérieure • Altura externa - Altura interna (mm) 2900-1995

# Koala

RIMOR



Questa nuova linea si rivolge al pubblico assicurando competitività nel prezzo ed un design attento e ricercato.

Costruito su meccanica Fiat Ducato, Trimarano è un mezzo di sostanza, che saprà accompagnarvi nelle vostre vacanze. Fresco e moderno, il layout esterno concilia i nuovi colori con la solidità costruttiva tipica di Rimor. La cura degli interni si affida alla tradizione aziendale con un'ampia scelta di piante funzionali, adatte anche ad equipaggi numerosi.

The new Trimarano serie offers to the public a classy and refined design with a competitive price. The Trimarano models are equipped on Fiat Ducato engines, thus resulting a camping car perfect for your holidays. The exterior design, fresh and contemporary, displays new colours on the historical RIMOR tradition of solid building. The interior design is driven by the company tradition's landmarks in a wide offer of functional layouts, dedicated to the small crew as well as the bigger families.

TRIMARANO, so wird diese Neue Generation von AUTOCARAVANS RIMOR genannt, dieses Neue Reisemobil mit diesem Namen ist mit einem ansprechenden Design versehen, wirkt dadurch sehr elegant und hat einen attraktiven Preis. Der TRIMARANO wird auf dem Fiat DUCATO gefertigt und hat somit eine technisch ausgereifte Basis als Fahrzeug und begleitet Sie auf allen Reisen. Alle Bedienteile sind zweckmäßig, robust und lassen auch mehrere Personen im TRIMARANO den Urlaub genießen.

Ce nouvel modèle Vous assure un prix compétitif et un design attentif et recherché. Réalisé sur mécanique Fiat Ducato, Trimarano est un véhicule puissant, qui pourra Vous suivre dans votre vacances. Frais et moderne, le lay-out à l'extérieur gagne la nouveauté des couleurs avec la solidité de la réalisation typique de Rimor. Le soin des équipements se confie à la tradition de l'usine avec un grand choix des plans d'aménagement, idéal pour les familles nombreuses aussi.

Esta nueva línea se dirige al público asegurando competitividad en precio y un diseño moderno y elegante. Construido sobre mecánica Fiat Ducato, Trimarano es una autocaravana competitiva, que sabrá acompañarle en sus vacaciones. Fresco y moderno, la coloración externa concilia con los nuevos colores y con la solidez constructiva típica de Rimor. El cuidado del interior muestra la elegancia Rimor, con una amplia selección de distribuciones, adaptadas también a familias numerosas.

AUTOCARAVANS  
**RIMOR**





# Trimarano

RIMOR



Trimarano 9





# Trimarano

RIMOR

Trimarano 9



Trimarano 9





# Trimarano

RIMOR



Trimarano 9

Trimarano 9



Trimarano 9



## Timarano 69P

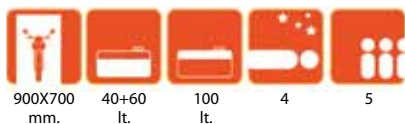
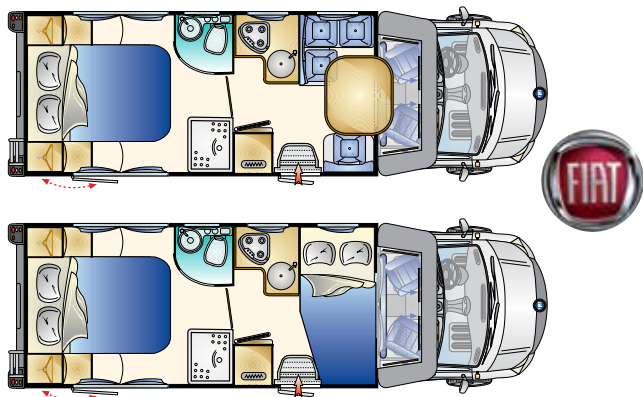

MISURE E PESI • DIMENSIONS AND WEIGHTS • MASSE UND GEWICHTE • DIMENSION ET POIDS • MEDIDAS Y PESOS

Lunghezza esterna • Outside length • Gesamtlänge • Longueur extérieure • Longitud externa (mm) 7414

Larghezza esterna - larghezza interna • Outside width - inside width • Gesamtbreite - Innenbreite • Largeur extérieure - intérieure • Anchura externa - Anchura interna (mm) 2340-2200

Altezza esterna fuori tutto - altezza interna • Maximum outside height - inside height • Gesamthöhe - Innenhöhe • Hauteur extérieure hors tout - intérieure • Altura externa - Altura interna (mm) 2900-1995

## Timarano 9

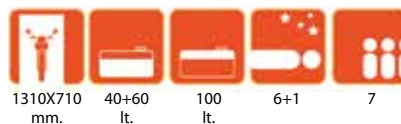
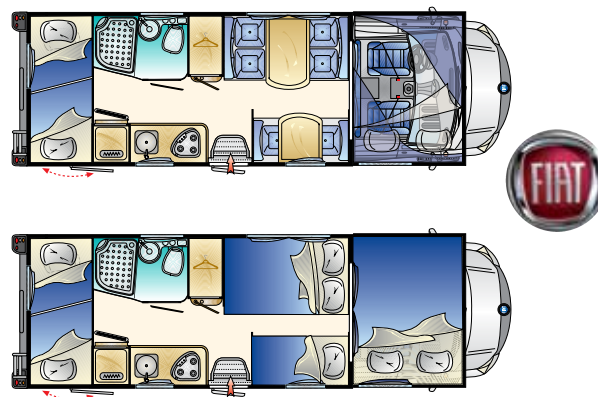

MISURE E PESI • DIMENSIONS AND WEIGHTS • MASSE UND GEWICHTE • DIMENSION ET POIDS • MEDIDAS Y PESOS

Lunghezza esterna • Outside length • Gesamtlänge • Longueur extérieure • Longitud externa (mm) 7369

Larghezza esterna - larghezza interna • Outside width - inside width • Gesamtbreite - Innenbreite • Largeur extérieure - intérieure • Anchura externa - Anchura interna (mm) 2340-2200

Altezza esterna fuori tutto - altezza interna • Maximum outside height - inside height • Gesamthöhe - Innenhöhe • Hauteur extérieure hors tout - intérieure • Altura externa - Altura interna (mm) 3000-1995

## Timarano 8P

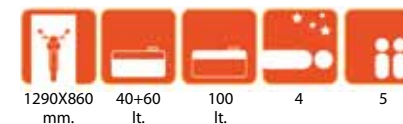
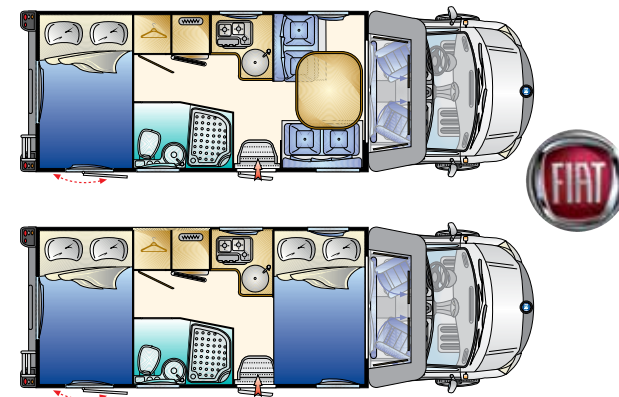

MISURE E PESI • DIMENSIONS AND WEIGHTS • MASSE UND GEWICHTE • DIMENSION ET POIDS • MEDIDAS Y PESOS

Lunghezza esterna • Outside length • Gesamtlänge • Longueur extérieure • Longitud externa (mm) 7153

Larghezza esterna - larghezza interna • Outside width - inside width • Gesamtbreite - Innenbreite • Largeur extérieure - intérieure • Anchura externa - Anchura interna (mm) 2340-2200

Altezza esterna fuori tutto - altezza interna • Maximum outside height - inside height • Gesamthöhe - Innenhöhe • Hauteur extérieure hors tout - intérieure • Altura externa - Altura interna (mm) 2900-1995



## Timarano 8

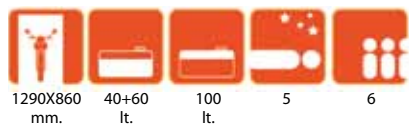
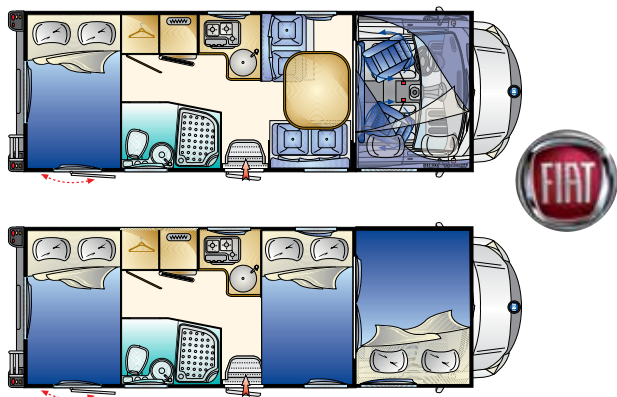

MISURE E PESI • DIMENSIONS AND WEIGHTS • MASSE UND GEWICHTE • DIMENSION ET POIDS • MEDIDAS Y PESOS

Lunghezza esterna • Outside length • Gesamtlänge • Longueur extérieure • Longitud externa (mm) 7153

Larghezza esterna - larghezza interna • Outside width - inside width • Gesamtbreite - Innenbreite • Largeur extérieure - intérieure • Anchura externa - Anchura interna (mm) 2340-2200

Altezza esterna fuori tutto - altezza interna • Maximum outside height - inside height • Gesamthöhe - Innenhöhe • Hauteur extérieure hors tout - intérieure • Altura externa - Altura interna (mm) 3000-1995

## Timarano 5

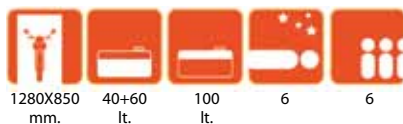
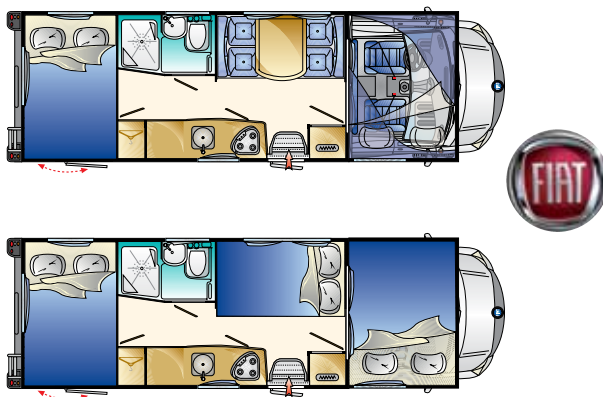

MISURE E PESI • DIMENSIONS AND WEIGHTS • MASSE UND GEWICHTE • DIMENSION ET POIDS • MEDIDAS Y PESOS

Lunghezza esterna • Outside length • Gesamtlänge • Longueur extérieure • Longitud externa (mm) 7153

Larghezza esterna - larghezza interna • Outside width - inside width • Gesamtbreite - Innenbreite • Largeur extérieure - intérieure • Anchura externa - Anchura interna (mm) 2340-2200

Altezza esterna fuori tutto - altezza interna • Maximum outside height - inside height • Gesamthöhe - Innenhöhe • Hauteur extérieure hors tout - intérieure • Altura externa - Altura interna (mm) 3000-1995

## Timarano 3

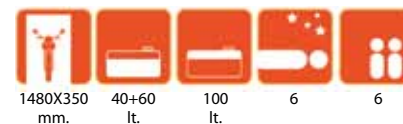
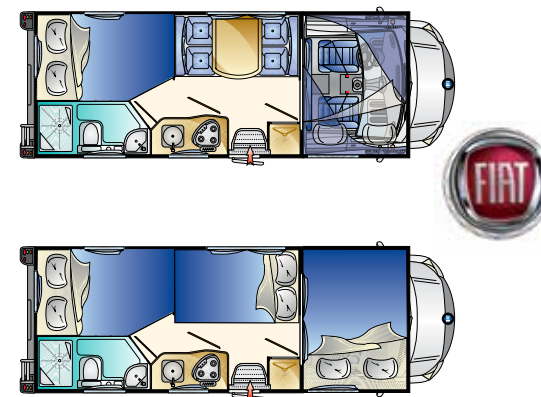

MISURE E PESI • DIMENSIONS AND WEIGHTS • MASSE UND GEWICHTE • DIMENSION ET POIDS • MEDIDAS Y PESOS

Lunghezza esterna • Outside length • Gesamtlänge • Longueur extérieure • Longitud externa (mm) 6478

Larghezza esterna - larghezza interna • Outside width - inside width • Gesamtbreite - Innenbreite • Largeur extérieure - intérieure • Anchura externa - Anchura interna (mm) 2340-2200

Altezza esterna fuori tutto - altezza interna • Maximum outside height - inside height • Gesamthöhe - Innenhöhe • Hauteur extérieure hors tout - intérieure • Altura externa - Altura interna (mm) 3000-1995



Pensato per le famiglie numerose, il Katamarano, è ormai un classico dello stile Rimor a cui non si può rinunciare. Adatto a chi si avvicina per la prima volta al mondo dell'autocaravan mantiene gli standard tipici della qualità Rimor pur restando un mezzo di primo prezzo. Costruito su meccanica Ford, la disposizione interna è di tipo classico, con ampi volumi abitativi e ottime possibilità di carico.

Developed for big families, the Katamarano has become classic of Rimor style and can't be given up. Ideal for anyone as an entry-level vehicle, it retains the standards that are typical for Rimor quality at an extremely affordable price. Built on Ford chassis, the Katamarano has a classic layout, with a large living area and huge storage possibilities.

Für grössere Familien ideal, der Katamarano ist zum unverzichtbaren Rimor-Klassiker geworden. Optimal auch für diejenigen, die sich zum ersten Mal für ein Wohnmobil entscheiden. Dieses Fahrzeug hat alle typischen Merkmale der Rimor-Qualität trotz einem perfekten Preis/Leistungsverhältnisses. Der Katamarano auf Ford-Motorisierung hat eine klassische Innenausstattung mit viel Platz und grossen Stauräumen.

Idéal pour les familles nombreuses, le Katamarano, dans le plus pur style Rimor est aujourd'hui un grand classique du genre. Il a été conçu en pensant aux nouveaux venus dans le monde du camping-car, il maintient les standards Rimor restant ainsi un véhicule économique. Construit sur mécanique Ford, l'agencement intérieur est classique, avec de grands espaces de vie et des grandes possibilités de chargement.

Pensado para las familias numerosas, el Katamarano es ya un clásico del estilo Rimor del que no podemos renunciar. Adecuado a quien se aproxima por primera vez al mundo de la autocaravana manteniendo el standard típico de la calidad Rimor aun siendo un vehículo de primer precio. Construido sobre mecánica Ford, la distribución interna es de tipo clásico, con amplios volúmenes y excelentes posibilidades de carga.





# Katamarano

RIMOR



Katamarano 1





# Katamarano

RIMOR



Katamarano 1



Katamarano 1

Katamarano 1







# Katamarano

RIMOR

Katamarano 1



Katamarano 1



Katamarano 1





# Katamarano

RIMOR



Katamarano 12P





# Katamarano

RIMOR



Katamarano 12P



Katamarano 12P



Katamarano 12P

## Katamarano Sound

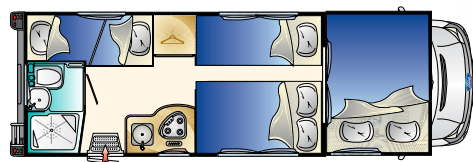
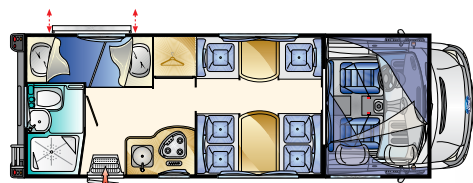

1350X950  
mm. 40+60  
lt. 100  
lt. 7  
7

MISURE E PESI • DIMENSIONS AND WEIGHTS • MASSE UND GEWICHTE • DIMENSION ET POIDS • MEDIDAS Y PESOS

Lunghezza esterna • Outside length • Gesamtlänge • Longueur extérieure • Longitud externa (mm) 5680

Larghezza esterna - larghezza interna • Outside width - inside width • Gesamtbreite - Innenbreite • Largeur extérieure - intérieure • Anchura externa - Anchura interna (mm) 2240-2100

Altezza esterna fuori tutto - altezza interna • Maximum outside height - inside height • Gesamthöhe - Innenhöhe • Hauteur extérieure hors tout - intérieure • Altura externa - Altura interna (mm) 2900-1995

## Katamarano 12P

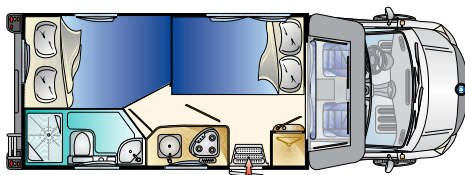
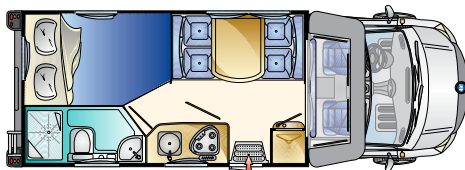

1450X350  
mm. 40+60  
lt. 100  
lt. 4  
6

MISURE E PESI • DIMENSIONS AND WEIGHTS • MASSE UND GEWICHTE • DIMENSION ET POIDS • MEDIDAS Y PESOS

Lunghezza esterna • Outside length • Gesamtlänge • Longueur extérieure • Longitud externa (mm) 6478

Larghezza esterna - larghezza interna • Outside width - inside width • Gesamtbreite - Innenbreite • Largeur extérieure - intérieure • Anchura externa - Anchura interna (mm) 2340-2200

Altezza esterna fuori tutto - altezza interna • Maximum outside height - inside height • Gesamthöhe - Innenhöhe • Hauteur extérieure hors tout - intérieure • Altura externa - Altura interna (mm) 2900-1995

## Katamarano 7

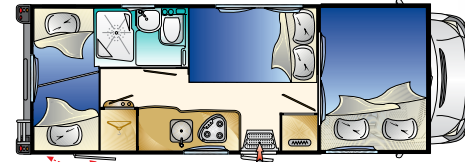
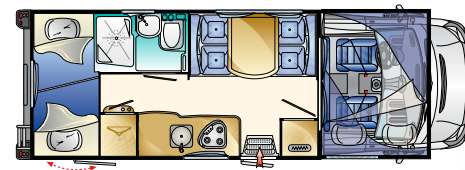

1310X760  
mm. 40+60  
lt. 100  
lt. 6  
6

MISURE E PESI • DIMENSIONS AND WEIGHTS • MASSE UND GEWICHTE • DIMENSION ET POIDS • MEDIDAS Y PESOS

Lunghezza esterna • Outside length • Gesamtlänge • Longueur extérieure • Longitud externa (mm) 6444

Larghezza esterna - larghezza interna • Outside width - inside width • Gesamtbreite - Innenbreite • Largeur extérieure - intérieure • Anchura externa - Anchura interna (mm) 2240-2100

Altezza esterna fuori tutto - altezza interna • Maximum outside height - inside height • Gesamthöhe - Innenhöhe • Hauteur extérieure hors tout - intérieure • Altura externa - Altura interna (mm) 2900-1995



## Katamarano 1

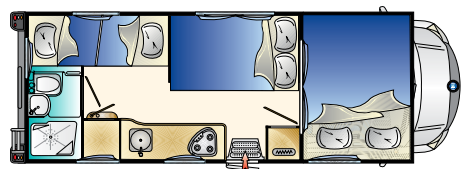
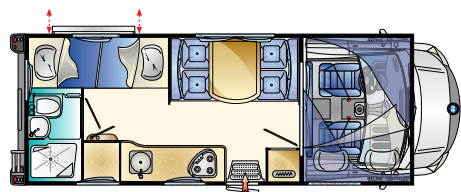

## Katamarano 1 light

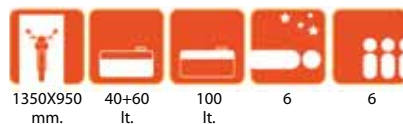
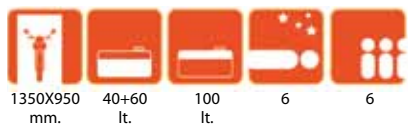
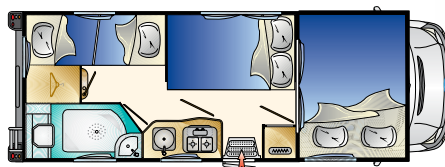
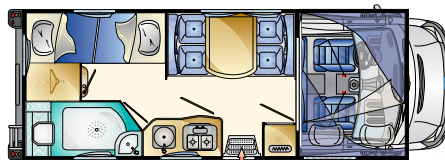

MISURE E PESI • DIMENSIONS AND WEIGHTS • MASSE UND GEWICHTE • DIMENSION ET POIDS • MEDIDAS Y PESOS

Lunghezza esterna • Outside length • Gesamtlänge • Longueur extérieure • Longitud externa (mm) 6484

Larghezza esterna - larghezza interna • Outside width - inside width • Gesamtbreite - Innenbreite • Largeur extérieure - intérieure • Anchura externa - Anchura interna (mm) 2240-2100

Altezza esterna fuori tutto - altezza interna • Maximum outside height - inside height • Gesamthöhe - Innenhöhe • Hauteur extérieure hors tout - intérieure • Altura externa - Altura interna (mm) 2900-1995

MISURE E PESI • DIMENSIONS AND WEIGHTS • MASSE UND GEWICHTE • DIMENSION ET POIDS • MEDIDAS Y PESOS

Lunghezza esterna • Outside length • Gesamtlänge • Longueur extérieure • Longitud externa (mm) 6484

Larghezza esterna - larghezza interna • Outside width - inside width • Gesamtbreite - Innenbreite • Largeur extérieure - intérieure • Anchura externa - Anchura interna (mm) 2240-2100

Altezza esterna fuori tutto - altezza interna • Maximum outside height - inside height • Gesamthöhe - Innenhöhe • Hauteur extérieure hors tout - intérieure • Altura externa - Altura interna (mm) 2900-1995

# Katamarano

RIMOR



Per chi non ama perdere tempo l'Horus 30 è un mezzo veramente dinamico e divertente. Spirito sportivo l'Horus 30 è il van di ultima generazione costruito per chi ama l'avventura della vita all'aria aperta. Allestito su furgonato Ford Transit a trazione anteriore l'Horus presenta una pianta interna funzionale, capace di usufruire in modo pratico degli spazi.

Perfect for people who want to save time, the Horus 30 is a truly dynamic and lively vehicle.

It is the latest generation van with sporty spirit. The Horus 30 is suited for people who love adventure and outdoor holidays. Fitted on a front-wheel drive Ford Transit van, the Horus has a functional interior layout conceived to make the most of every space.

Der Horus 30 ist das ideale Fahrzeug für diejenigen, die keine Zeit verlieren wollen und ein junges und dynamisches Mobil möchten.

Der sportliche Horus 30 ist der Kastenwagen neuester Generation für Abenteuer-Liebhaber in der Natur und an der frischen Luft. Der Horus mit Frontantrieb und auf Ford Transit gebaut, hat einen sehr funktionstauglichen Grundriss der den Platz optimal zur Geltung bringt. Idéal pour ceux qui prennent la vie à plein poumons, l'Horus 30 est un véhicule vraiment dynamique et vif.

Avec un esprit sportif l'Horus 30 est le van de nouvelle génération qui a été pensé et décidé pour ceux qui aiment l'aventure et la vie en plein air. Monté sur un fourgon Ford Transit à traction avant l'Horus présente un aménagement intérieur fonctionnel, exploitant au mieux chaque espace.

El Horus es una van dinámica y divertida con espíritu deportivo, el Horus 30 es el van de última generación construido para quien ama la aventura de la vida al aire libre. Construido sobre mecánica Ford con tracción delantera presenta una distribución interna funcional, capaz de aprovechar de manera práctica todos los espacios.

AUTOCARAVANS  
**RIMOR**





# Horus

RIMOR







# Horus

RIMOR







# Horus

RIMOR

## Horus

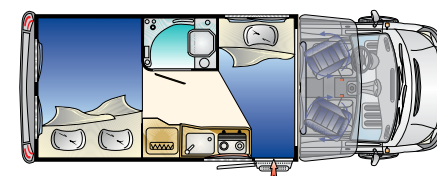
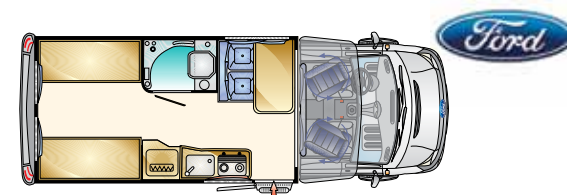

90  
lt.

48+48  
lt.

3

4



MISURE E PESI • DIMENSIONS AND WEIGHTS • MASSE UND GEWICHTE • DIMENSION ET POIDS • MEDIDAS Y PESOS

Lunghezza esterna • Outside length • Gesamtlänge • Longueur extérieure • Longitud externa (mm) 5680

Larghezza esterna - larghezza interna • Outside width - inside width • Gesamtbreite - Innenbreite • Largeur extérieure - intérieure • Anchura externa - Anchura interna (mm) 1974-1820

Altezza esterna fuori tutto - altezza interna • Maximum outside height - inside height • Gesamthöhe - Innenhöhe • Hauteur extérieure hors tout - intérieure • Altura externa - Altura interna (mm) 2700-1940

### mod. ICE/D

	STANDARD	OPTIONAL
Katamarano	-	0
Trimarano	-	0
Koala	-	0
Europeo	-	0
Nemho	●	0
Sailer	●	0
Horus	-	0



▶ Tessuto  
Fabric  
Polsterstoff  
Tissus  
Tejido



### mod. FASCINO/V

	STANDARD	OPTIONAL
Katamarano	-	0
Trimarano	-	0
Koala	-	0
Europeo	●	0
Nemho	-	0
Sailer	-	0
Horus	-	0



▶ Tessuto  
Fabric  
Polsterstoff  
Tissus  
Tejido



### mod. COPY

	STANDARD	OPTIONAL
Katamarano	●	0
Trimarano	-	0
Koala	-	0
Europeo	-	0
Nemho	-	0
Sailer	-	0
Horus	-	0



▶ Tessuto  
Fabric  
Polsterstoff  
Tissus  
Tejido







### mod. FUNKY

	STANDARD	OPTIONAL
Katamarano	-	0
Trimarano	●	0
Koala	-	0
Europeo	-	0
Nemho	-	0
Sailer	-	0
Horus	-	0



▶ Tessuto  
Fabric  
Polsterstoff  
Tissus  
Tejido



### mod. ORIZON

	STANDARD	OPTIONAL
Katamarano	-	0
Trimarano	-	0
Koala	●	0
Europeo	-	0
Nemho	-	0
Sailer	-	0
Horus	-	0



▶ Tessuto  
Fabric  
Polsterstoff  
Tissus  
Tejido



### mod. DAM

	STANDARD	OPTIONAL
Katamarano	-	0
Trimarano	-	0
Koala	-	0
Europeo	-	0
Nemho	-	0
Sailer	-	0
Horus	●	0



▶ Tessuto  
Fabric  
Polsterstoff  
Tissus  
Tejido



La forma dei cuscini è indicativa - Cushions' shape is merely indicative - Kissenform bleibt bei Polsterstoffänderung gleich - La forme des coussins est indicative - La forma de los cojines es orientativa

Dati tecnici e caratteristiche dei veicoli riportati nel catalogo sono puramente indicativi.

Il costruttore e il distributore non sono pertanto responsabili di eventuali variazioni che, per qualche motivo, dovessero essere apportate nel corso della stagione.

The information given in this catalogue is purely indicative and is not in any way a description of specific features by the manufacturer or distributor.

Die in diesem Katalog enthaltenen Informationen sind nicht verbindlich und stellen auf keine Weise eine Beschreibung der speziellen Merkmale durch den Hersteller oder den Händler dar.

Les données et caractéristiques techniques des véhicules figurant dans le catalogue sont purement indicatives.

Aussi, le constructeur et le distributeur ne sont aucunement tenus de répondre des éventuelles variations apportées, pour quelque raison que ce soit, en cours de saison.

Los datos técnicos y las características de los vehículos presentes en el catálogo son puramente indicativos.

Por lo tanto, el fabricante y el distribuidor no se hacen responsables de eventuales cambios que, por cualquier razón, se introduciesen durante la temporada.

DEALER



[www.rimor.it](http://www.rimor.it)

Loc. Fosci, strada per Orneto - 53036 Poggibonsi (Siena) Italia  
Tel. +39 0577 98851 - Fax +39 0577 988305





[www.rimor.it](http://www.rimor.it)